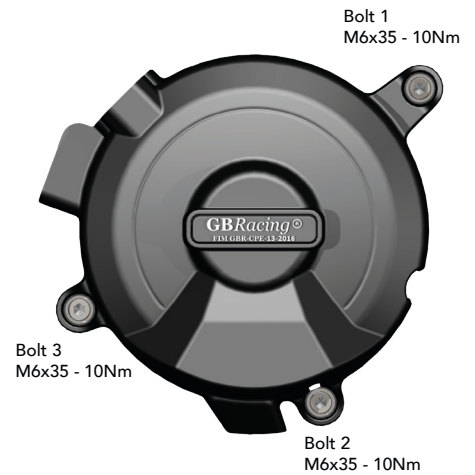
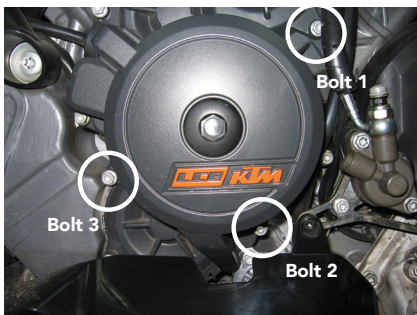

THIS SHEET INCLUDES FITTING INSTRUCTIONS FOR THE FOLLOWING PARTS:

Secondary Alternator Cover Part No. EC-RC8-2011-1-GBR / Secondary Clutch Cover Part No. EC-RC8-2008-2-GBR
Frame Slider Set - Part No. CP-RC8-2008-SET-GBR / Paddock Stand / Bobbin Set Part No. BA12-8-GBR-SET**SECONDARY ALTERNATOR COVER**
PART NO. EC-RC8-2011-1-GBR

- 1 Remove side fairing.
- 2 Remove 3 existing bolts from the stock Alternator cover, shown as position Bolt 1, 2 & 3.
- 3 Place the Secondary Alternator Cover over the stock cover.
- 4 Assemble 3 replacement bolts loosely in the correct position as shown.
- 5 Tighten bolts to a Torque of 10Nm as per Manufacturer's recommendations.
DO NOT OVERTIGHTEN.

**SECONDARY CLUTCH COVER**
PART NO. EC-RC8-2008-2-GBR

- 1 Remove 3 existing bolts from the stock Clutch cover, shown as position Bolt 1, 2 & 3.
- 2 Place the Secondary Clutch Cover over the stock cover.
- 3 Assemble 3 replacement bolts loosely in the correct position as shown.
Note. 100mm to the top, 95mm to the bottom left.
- 4 Tighten bolts to a Torque of 10Nm as per Manufacturer's recommendations.
DO NOT OVERTIGHTEN.

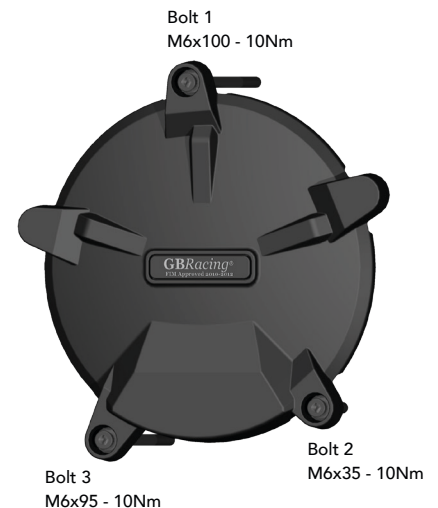
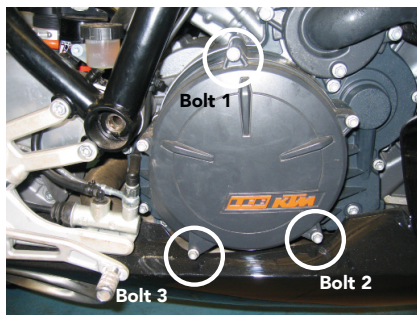

FRAME SLIDER RIGHT HAND SIDE
PART NO. CP-RC8-2008-RHS-GBR

- 1 Remove 2 existing bolts, shown above at Bolt positions 1 & 2.
Note:- Remove aluminium spacer bush at Bolt position 1.
- 2 Place the Black Anodised Bracket into position, assemble using 2 off supplied M10 x 55 Zinc plated 12.9 Steel Bolts.
- 3 Tighten bolts to a Torque of 48Nm as per Manufacturer's recommendations. **DO NOT OVERTIGHTEN.**
- 4 Assemble the CPF1-GBR mushroom with the supplied M10 x 65 A2 Stainless Steel Bolt. Tighten to 25 Nm.

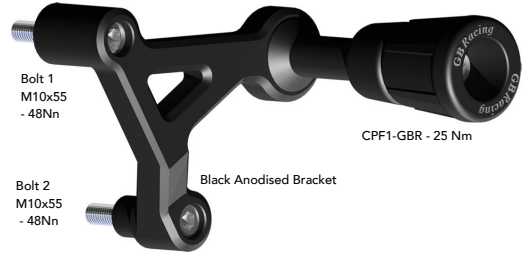
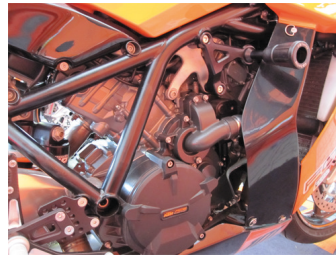
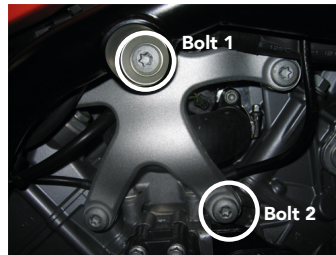

FRAME SLIDER LEFT HAND SIDE
PART NO. CP-RC8-2008-LHS-GBR

- 1 Remove 2 existing bolts, shown above at Bolt positions 1 & 2.
Note:- Remove aluminium spacer bush at Bolt position 1.
- 2 Place the Black Anodised Bracket into position, assemble using 2 off supplied M10 x 55 Zinc plated 12.9 Steel Bolts.
- 3 Tighten bolts to a Torque of 48Nm as per Manufacturer's recommendations. **DO NOT OVERTIGHTEN.**
- 4 Assemble the CPF1-GBR mushroom with the supplied M10 x 65 A2 Stainless Steel Bolt. Tighten to 25 Nm.

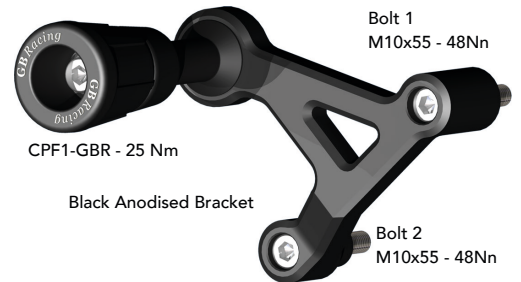
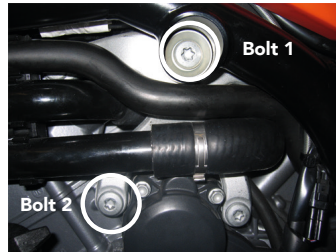

PADDOCK STAND / BOBBIN SET
PART NO. BA12-8-GBR-SET

- 1 Assemble M8 x 40mm Bolt through the moulded bobbin.
- 2 Tighten bolts to swing arm boss, 8 Nm.
DO NOT OVERTIGHTEN



1 x M8 x 40 Bolt
1 x Moulded Paddock Stand / Bobbin



Protection Bundle: CP-RC8-2011-CS-GBR

EC-RC8-2011-1-GBR, EC-RC8-2008-2-GBR, CP-RC8-2008-SET-GBR, BA12-8-GBR-SET

Engine Cover Set: EC-RC8-2011-SET-GBR

EC-RC8-2011-1-GBR, EC-RC8-2008-2-GBR