

**THIS SHEET INCLUDES FITTING INSTRUCTIONS FOR THE FOLLOWING PARTS:**

Secondary Alternator Cover Part No. EC-R9-2025-1-GBR / Secondary Clutch Cover Part No. EC-R9-2025-2-GBR /  
 Secondary Pulse Cover Part No. EC-R9-2025-3-GBR / Secondary Water Pump Cover Part No. EC-R9-2021-5-GBR  
 Bullet Frame Slider Set Part No. FS-MT09-2021-S / XSR900 2022-2024 & XSR900 GP 2024 MODELS ONLY: Frame Sliders STREET - Part No. FS-XSR900-2022-S

**SECONDARY ALTERNATOR COVER – PART NO. EC-R9-2025-1-GBR**

- 1 Remove 4 existing bolts from the stock Alternator cover, shown as position Bolts 1, 2, 3 & 4.
- 3 Place the Secondary Alternator Cover over the stock cover.
- 4 Assemble 4 replacement bolts loosely in the correct position as shown.
- 5 Tighten bolts to a Torque of 10Nm as per Manufacturer's recommendations. DO NOT OVERTIGHTEN.

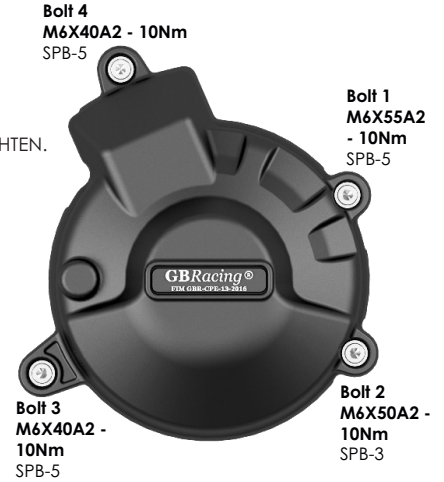
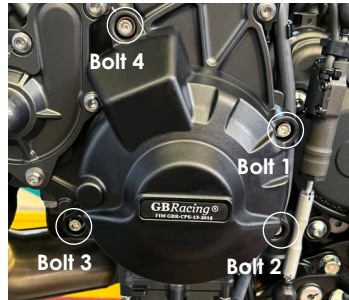
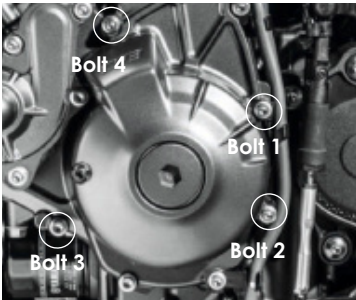

**SECONDARY CLUTCH COVER – PART NO. EC-R9-2025-2-GBR**

- 1 Please remove plastic dust cover before fitting the GBRacing cover – remove the bolts from the plastic dust cover. Put the left and top bolts (M6x30) back in their original locations (minus dust cover) See **Fig.1**.
- 2 Remove 4 existing bolts from the stock clutch cover, shown as position Bolts 1, 2, 3 & 4.
- 3 Place the Secondary Clutch Cover over the stock cover.
- 4 Assemble 4 replacement bolts loosely in the correct position as shown.
- 5 Tighten bolts to a Torque of 10Nm as per Manufacturer's recommendations. DO NOT OVERTIGHTEN.

**Fig 1**

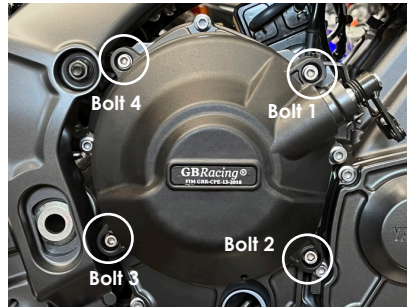

## SECONDARY PULSE COVER – PART NO. EC-R9-2025-3-GBR

**For the YZF-R9:** Remove the RHS fairing and snip off the internal fairing support as shown, in order to provide clearance for the GBRacing cover. The GBRacing cover will now work as the fairing support.

- 1 Remove the 4 standard bolts
- 2 Place the secondary pulse cover against the standard cover using the 4 supplied bolts.
- 3 Tighten all 4 bolts to 10nm as per manufacturer's recommendations  
DO NOT OVERTIGHTEN

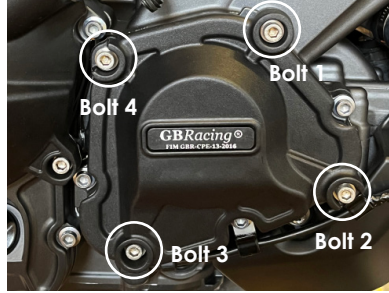
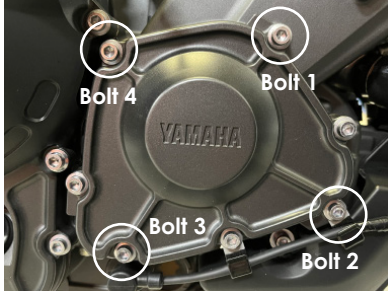

**Bolt 4**  
 M6X30A2 - 10Nm  
 SPB-5

**Bolt 1**  
 M6X30A2 - 10Nm  
 SPB-5  
 SPB-5

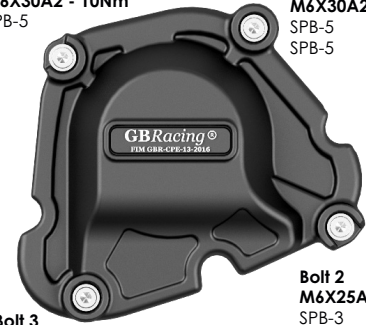

**Bolt 3**  
 M6X25A2 - 10Nm  
 SPB-3

**Bolt 2**  
 M6X25A2 - 10Nm  
 SPB-3

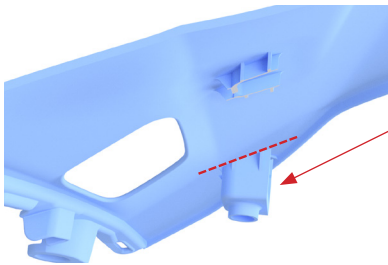

**For the YZF-R9:** Remove this bracket covering the Pulse cover  
 Maximum 5mm protrusion.

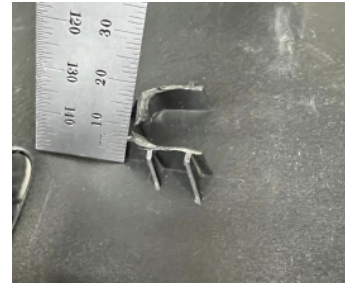

## SECONDARY WATER PUMP COVER PART NO. EC-R9-2025-5-GBR

- 1 Fitting requires a COLD engine.
- 2 Ensure radiator cap is firmly on. Do not loosen.
- 3 Remove Bolt 1 & 3 before removing Bolt 2. Once bolt 2 is removed you will lose approx 6 drops of coolant and it will not drip anymore. Follow **Fig 2**, to make sure that the supplied copper washers are in the correct positions.
- 4 Insert **Bolt 2** with the washers into correct hole and hand-tighten - See **Fig 1**.
- 5 Then insert Bolts 1 & 3 and tighten to correct torque setting 10Nm. DO NOT OVERTIGHTEN
- 6 Check the water level as per the manufacturer's recommendations.

**Fig. 1**

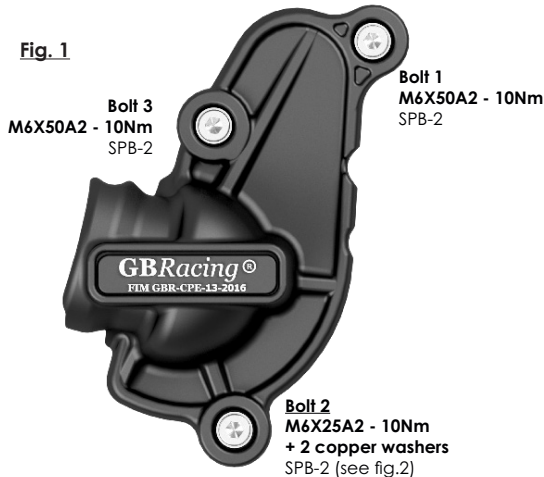

**Fig. 2**

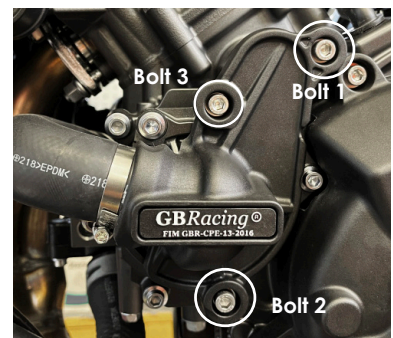
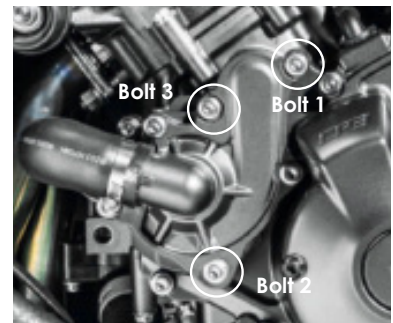
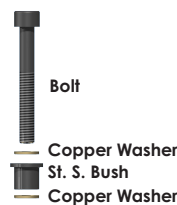

### SET: Engine Cover Set: EC-R9-2025-SET-GBR

Secondary Alternator Cover Part No. EC-R9-2025-1-GBR / Secondary Clutch Cover Part No. EC-R9-2025-2-GBR /  
 Secondary Pulse Cover Part No. EC-R9-2025-3-GBR / Secondary Water Pump Cover Part No. EC-R9-2025-5-GBR

**FIT MT-09 MODELS ONLY**

**BULLET FRAME SLIDER SET: BOTH SIDES**  
 PART NO. FS-MT09-2021-S

- 1 Remove upper engine mounting bolt.
- 2 Assemble bolt through the aluminium bush into correct position.
- 3 Tighten to 60NM torque.
- 4 Slide bullet moulding onto aluminium bush.
- 5 Screw M6 bolt through moulding hand tight.

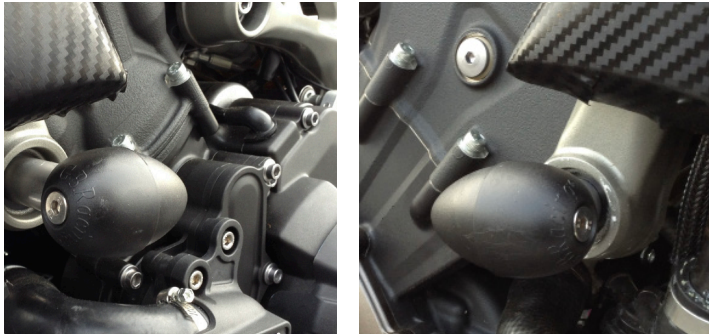

**LEFT HAND SIDE**

FS-MT09-2021-LHS-S



**RIGHT HAND SIDE**

FS-MT09-2021-RHS-S



**REPLACEMENT BULLET MOULDED PART**

Part No. CPM-3

or

**CPM-3-GP**

This essentially replaces the CPM-3 puck, allowing a GoPro camera mount to be attached to the bike using our mounting system.



**FIT XSR900 2022-2023 & XSR900 GP 2024 MODELS ONLY: BULLET FRAME SLIDER SET - Part No. FS-XSR900-2022-S:**

**BULLET FRAME SLIDER - LEFT HAND SIDE - STREET**  
 - PART NO. FS-XSR900-2022-LHS-S



**BULLET FRAME SLIDER - RIGHT HAND SIDE - STREET**  
 - PART NO. FS-XSR900-2022-RHS-S



INSTRUCTIONS FOR THESE PARTS:

1. Remove front engine mounting bolt with washer.  
 NOTE: On the RHS do not remove the conical washer.
2. Assemble bolt through the aluminium bush into correct position.

3. Tighten to 40NM torque.
4. Slide bullet moulding onto aluminium bush.
5. Screw M6 bolt into front of bullet moulding hand tight.