

THIS SHEET INCLUDES FITTING INSTRUCTIONS FOR THE FOLLOWING PARTS:

Secondary Alternator Cover Part No. EC-ZX6-2009-1-GBR / Secondary Clutch Cover Part No. EC-ZX6-2009-2-GBR /

Secondary Pulse Cover Part No. EC-ZX6-2007-3-GBR /

Bobbin Set Part No. BA12-10-GBR-SET / Lower Chain Guard Part No. CGA09-GBR / Lower Chain Guard Part No. CGA29-GBR



SECONDARY ALTERNATOR COVER
PART NO. EC-ZX6-2009-1-GBR

- 1 Remove lower fairing.
- 2 Remove 4 existing bolts from the stock Alternator cover, shown as position Bolt 1, 2, 3 & 4.
- 3 Place the Secondary Alternator Cover over the stock cover.
- 4 Assemble 4 replacement bolts loosely in the correct position as shown.
- 5 Tighten bolts to a Torque of 11Nm as per manufacturers recommendations. **DO NOT OVERTIGHTEN.**
- 6 Re-Fit lower Fairing.

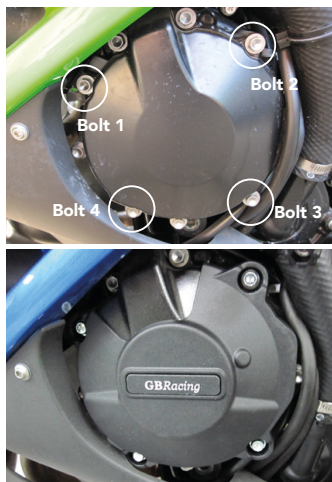

SECONDARY CLUTCH COVER
PART NO. EC-ZX6-2009-2-GBR

- 1 Remove lower fairing.
- 2 Remove 4 existing bolts from the stock clutch cover, shown as position Bolt 1, 2, 3 & 4.
- 3 Place the Secondary Clutch Cover over the stock cover.
- 4 Assemble 4 replacement M6x30 bolts, loosely in the correct position as shown.
- 5 Tighten bolts to a Torque of 11Nm as per manufacturers recommendations. **DO NOT OVERTIGHTEN.**
- 6 Re-Fit lower Fairing.

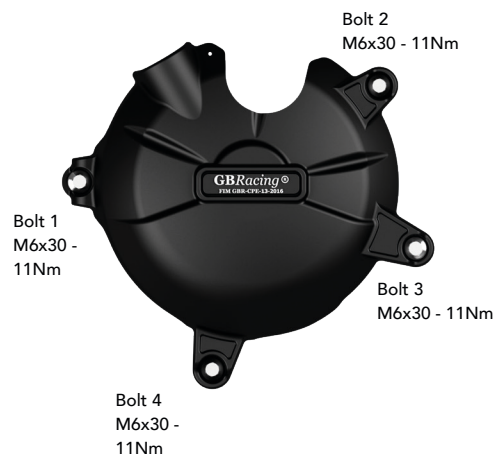
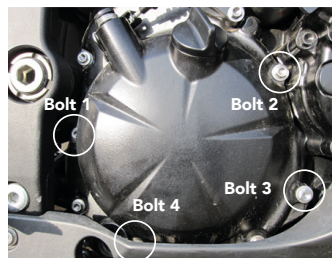

SECONDARY PULSE COVER
PART NO. EC-ZX6-2007-3-GBR

- 1 Remove the Upper and Lower Fairings.
- 2 Remove 4 existing bolts from the stock pulse cover, shown as position Bolt 1, 2, 3 & 4.
- 3 Place the Secondary Pulse Cover over the stock cover.
- 4 Assemble 2 replacement M6x35, 1 replacement M6x25 & 1 replacement M6x45 bolts, loosely in the correct position as shown.
- 5 Tighten bolts to a Torque of 11Nm as per Manufacturer's recommendations. **DO NOT OVERTIGHTEN.**
- 6 Re-Fit the Fairings.

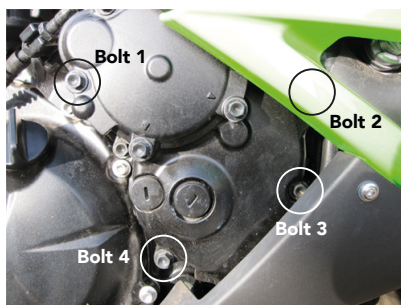

PADDOCK STAND / BOBBIN SET
PART NO. BA12-10-GBR-SET

- 1 Assemble the M10 Stainless Steel bolt through the moulded bobbin and the Black Anodised Bush.
- 2 Tighten bolts to the swing arm boss, 8 N/m.
DO NOT OVERTIGHTEN.

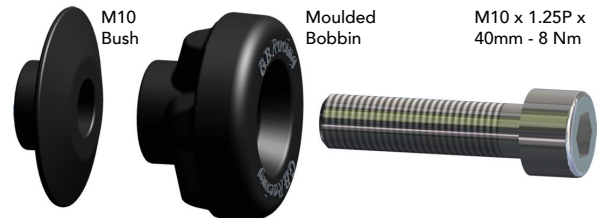
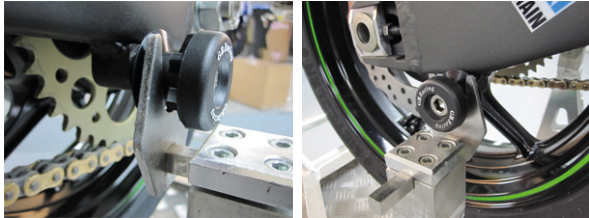

LOWER CHAIN GUARD
PART NO. CGA09-GBR

- 1 Assemble 2 off M6 x 20mm bolts and washers through the moulded lower chain guard into the Black Anodised aluminium mounting block CGA09-2.
- 2 Position the assembly underneath the swing arm, closing the gap to the rear sprocket.
Note : There should be a 5mm minimum gap from the bike chain to the lower chain guard.
- 3 Mark the position of the Black Anodised block, relative to the swing arm.
- 4 Disassemble the assembly, leaving the block to be replaced into the correct position.
Mark the C/Sunk fixing hole positions on the underside of the swing arm.
- 5 Drill & Tap the marked holes , M6 - (Drill 5mm Dia. for tapping)
- 6 Re-assemble the lower chain guard to the fixed block.

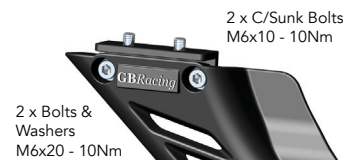

LOWER CHAIN GUARD
PART NO. CGA29-GBR

- 1 Assemble 2 bolts and washers through the lower chain guard into the Black Anodised aluminium mounting block CGA09-2.
- 2 Position the assembly underneath the swing arm, closing the gap to the rear sprocket.
Note : There should be a 5mm minimum gap from the bike chain to the lower chain guard.
- 3 Mark off the chosen hole positions.
- 4 Drill & Tap the marked holes , M6 - (Drill 5mm Dia. for tapping)
- 5 Disassemble the Black Anodised block from the assembly, and mount the block to the underside of the swing arm using the remaining 2 bolts and washers.
- 6 Re-assemble the lower chain guard to the fixed bracket.

2 x Bolts & Washers
M6x20 - 10Nm



www.GBRacing.eu

Protection Bundle: CP-ZX6-2007-CS-GBR

EC-ZX6-2009-1-GBR, EC-ZX6-2009-2-GBR, EC-ZX6-2007-3-GBR, CGA09-GBR, BA12-10-GBR-SET

Engine Cover Set: EC-ZX6-2007-SET-GBR

EC-ZX6-2009-1-GBR, EC-ZX6-2009-2-GBR, EC-ZX6-2007-3-GBR